

GAMMA[®]

PROGRESSION

Els

STRINGING MACHINE

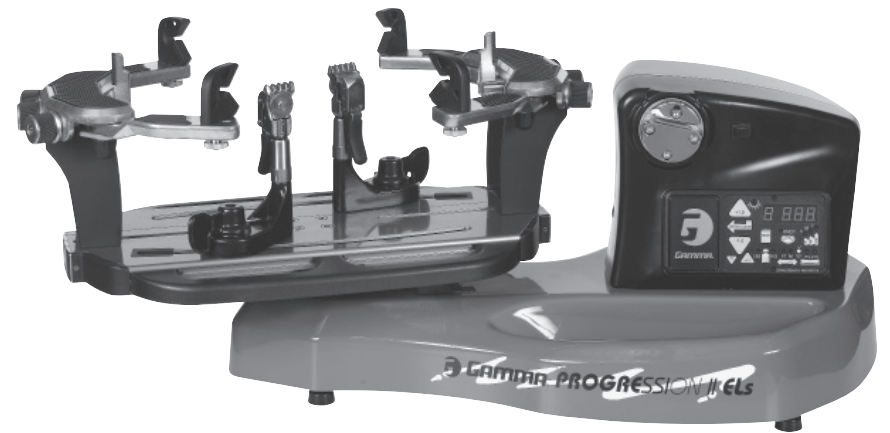

MMAN-30
(MPELS-12)

GAMMA SPORTS
200 Waterfront Drive
Pittsburgh, Pennsylvania 15222
Phone: 800.333.0337 Fax: 412.323.0317
Visit our website at www.gammasports.com

Copyright 2012 GAMMA Sports - All Rights Reserved

OWNER'S MANUAL
Issue 3 - November 2012

GAMMA[®] PROGRESSION

Els OWNER'S MANUAL TABLE OF CONTENTS

WARRANTY	PAGE 2
FEATURES.....	PAGE 3
ASSEMBLY INSTRUCTIONS	PAGE 4
POWER CONNECTION & CONTROLS	PAGE 5
MOUNTING THE FRAME	PAGE 7
STRINGING THE FRAME.....	PAGE 9
ADDITIONAL FEATURES	PAGE 12
PATHFINDER AWL.....	PAGE 13
CALIBRATION.....	PAGE 14
MAINTENANCE & ADJUSTMENTS	PAGE 15
TROUBLESHOOTING TIPS	PAGE 16
NOTES	PAGE 17
PARTS LIST	PAGE 18
PARTS DRAWING.....	PAGE 19

LIMITED WARRANTY

GAMMA Sports (GAMMA) warrants to the original purchaser that the Progression Els stringing machine ("EQUIPMENT") purchased is free from defects in materials and workmanship for a period of five (5) years from the date of original purchase for mechanical parts and for a period of one (1) year from the date of purchase for all electrical parts and string clamps. Should any defects develop under normal use within the specified time periods, GAMMA will at its option, repair or replace the defective EQUIPMENT provided it is returned to GAMMA prepaid at the purchaser's expense. This warranty does not apply to any damage or defect caused by negligence, abuse, misuse, unauthorized alteration, shipping, handling, or part wear and tear as a result of normal use.

Routine maintenance, adjustment, and cleaning required to ensure proper operation are the responsibility of the purchaser and are not covered under the terms of this warranty. These include, but are not limited to: String Clamp adjustment, as described on page 16, Quick Action Clamp Base adjustment, as described on page 16 and the cleaning procedures listed on page 17.

GAMMA's obligation under this warranty is limited to repair or replacement of defective EQUIPMENT, and no one is authorized to promise any other liability. GAMMA shall in no event be liable for any incidental or consequential damages.

To return defective EQUIPMENT, a return authorization (RA#) must be obtained from a GAMMA customer service representative. The RA# must be marked on the outside of the shipping carton being returned. All returns must be shipped prepaid by the customer to GAMMA. Please retain the original shipping carton and packing materials for any future shipments. GAMMA will not be responsible for machines which are not sent in the original undamaged packaging.

A GAMMA Care Service Plan is also available through GAMMA customer service, call 800.333.0337 for details.

PARTS DRAWING

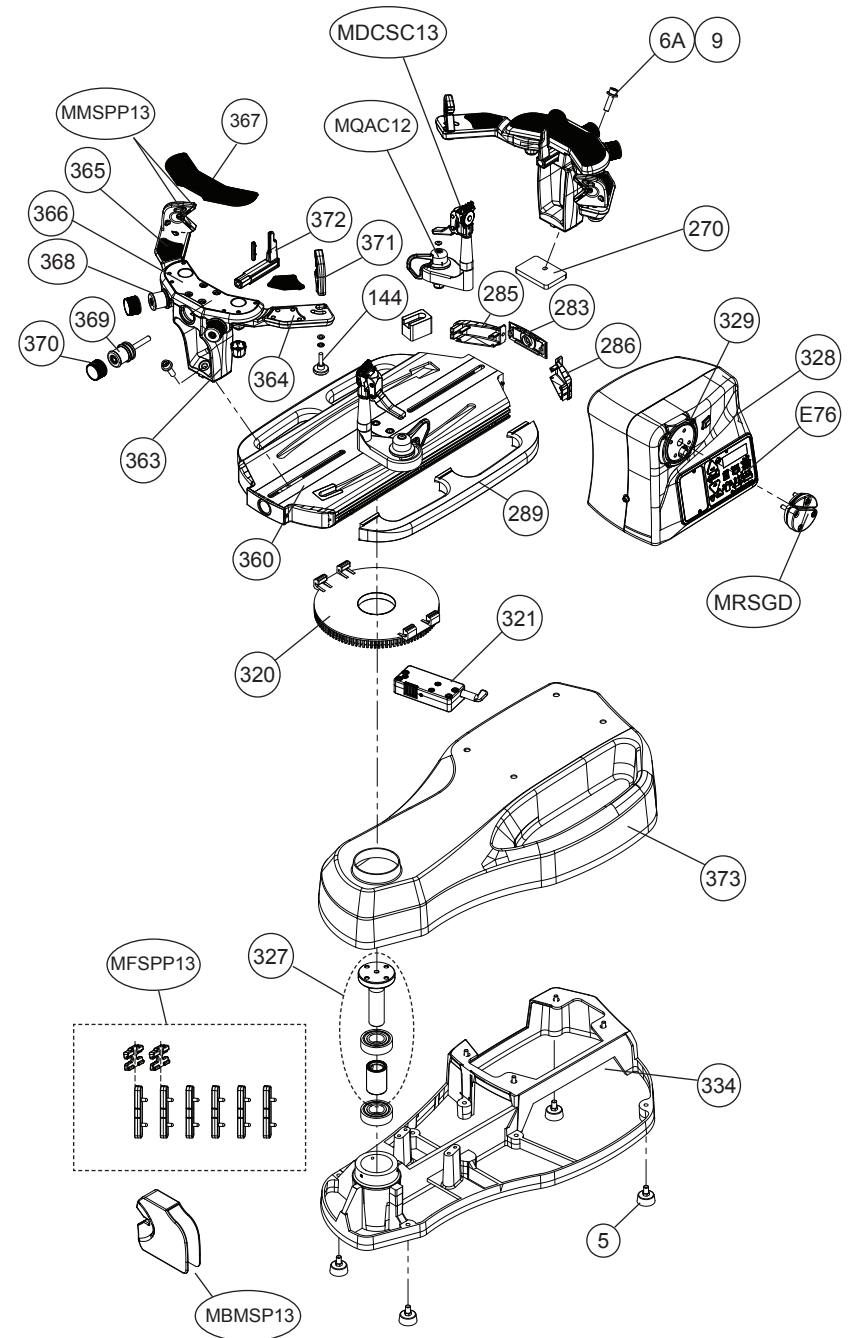

PARTS LIST

PART #	DESCRIPTION	TOOLS & ACCESSORIES	
5	RUBBER FOOT	71	6MM T-HANDLE HEX WRENCH*
6A	CAP SCREW- M8x30	109	NEEDLE NOSE PLIERS*
9	WASHER- M8	110	BENT NOSE PLIERS*
144	SHOULDER SUPP KNOB	167	HEX WRENCH SET*
203	TT BOLTS*	171	DIAGONAL CUTTERS*
270	SUPP POST MOUNT PLATE	196	17MM SOCKET*
283	TT END CAP	E16	A/C POWER CORD*
285	TT END CAP- RIGHT	E23	AC ADAPTER*
286	TT END CAP- LEFT	MA	STRINGER'S AWL*
289	TT HANDLES	MFSP13	FRAME SUPP PAD SET
320	BRAKE RING		6 FRAME PADS
321	BRAKE BOX		2 BAD SLIDE ON "H" PADS
327	TT PIN	MMSP13	TENNIS SHLDER SUPP PADS
328	TENSIONER	MBMSP11	BAD SHLDER SUPP COVER
329	GRIPPER DRUM	MPSA	PATHFINDER AWL*
334	BASE		* (NOT SHOWN)
360	TURNTABLE TT7		
363	A220 MOUNTING STAND		
364	A220 MNTG ARM (R)		
365	A220 MNTG ARM (L)		
366	A220 TOP PLATE		
367	A220 TOP PLATE/ARM PADS		
368	A220 ADJ KNOB & SCREW		
369	A220 FRAME SUPP KNOB	MMP11-16	#324 FOOT PEDAL SWITCH
370	ADJ KNOB RUBBER GRIP	MBFC	BADM FLOATING CLAMP
371	A220 SHOULDER V-MNT BLK	MBFS-14	BADM HEAD FRAME SUPP
372	A220 FRAME SUPPORT	MBMSS-11	BADM MOUNTING SYS UPG
373	MPELS BASE COVER (RED)	MGSMC	MACHINE COVER
E76	KEY PAD / ELECTRONICS	MPG	STARTING CLAMP
MDCSC13	UNIV DC STRING CLAMP	MPS	CLEANING STONE
MRSGD	DIE CAST GRIPPER	MPXFS	FLOOR STAND
MQAC12	QA BASE CLAMP	MTC	CALIBRATOR
		SGSM	STRINGER'S MAT

OPTIONAL TOOLS & ACCESS

FEATURES

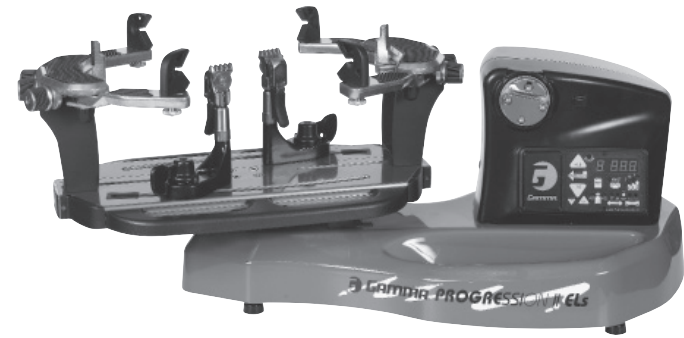

MACHINE FEATURES

- ❖ Electric Constant Pull Tensioner with 11.0 to 90.0 lbs Tension Range
- ❖ Digital Tension Setting with LED Display
- ❖ Parallel Jaw Rotating Gripper with Diamond Dust Coated Gripping Surfaces
- ❖ Professional Six Point "Quick Mount" Racquet Mounting System- Accommodates All Racquets
- ❖ Professional "Quick Action" Dual Action, Rotating, Metal Fixed String Clamps with Diamond Dust Coating
- ❖ Durable Polystyrene Base Cover with Convenient Padded Tool Tray
- ❖ Strong, Light Weight, Aluminum Construction
- ❖ Convenient Foot Actuated Tensioner Switch (Optional)

ASSEMBLY INSTRUCTIONS

NOTES



Remove this Screw

Transportation Screw

The machine has been shipped with a motor and load cell protection screw. Remove the screw before using the machine. Retain the screw for future shipment. Install the included rubber grommet into the hole.



String Clamp Installation

The post of the string clamp and tube of the string clamp base are treated with grease to provide protection against corrosion during shipping. Remove any excessive grease with a clean cloth prior to use. The post and tube may also be cleaned with isopropyl alcohol. After this type of thorough cleaning, the post and tube should be treated with a light coating of machine oil to protect the surfaces against corrosion and to ensure smooth operation.

TROUBLESHOOTING TIPS

<u>PROBLEM</u>	<u>SOLUTION</u>
String slips in clamps	- Adjust gap between clamp jaws - Clean clamp jaws
String slips in gripper	- Clean gripper jaws - Make sure string is wrapped over top gripper prior to inserting between gripper jaws
String clamp base slips on turntable	- Clean bottom of clamp & top of turntable with alcohol - Adjust clamp base locking nut
Electrical system does not function	- Check power source - Check power cord connections
String tension too tight or too loose	- Check tension using a tension calibrator, adjust machine calibration if necessary

CARE & CLEANING

With time and use, the clamping surfaces of your machine may become oily or dirty and result in string or clamp slippage while stringing. Periodic cleaning of the String Clamps, String Clamp Base and String Gripper is recommended. Knife sharpening stones work well for cleaning the diamond coated string clamping surfaces. Cleaning with a solvent such as isopropyl alcohol and a mild abrasive tool such as a toothbrush also works well to remove oily or greasy build up.

POWER CONNECTION & CONTROLS

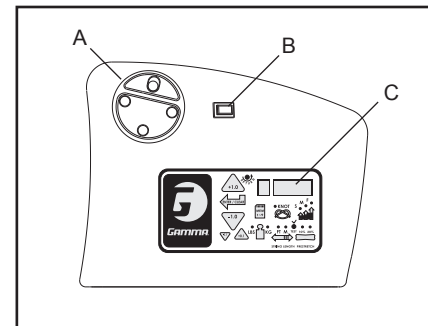

Front Panel Features

- A - String Gripper
- B - Tension Switch
- C - LED Tension Display

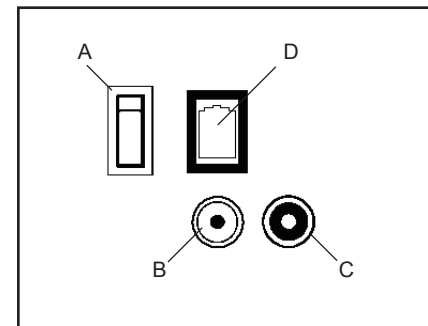

Back Panel Features

- A - Lighted Power Switch
- B - Foot Pedal Switch Receptacle
- C - A/C Power Cord Socket
- D - String Length Meter (currently not available)

Instructions for Power Connection and Controls

CAUTION ! Before connecting to the power supply, check the voltage source that the machine is being connected to. The acceptable range of input voltages for this machine is between 100 V and 240 V @ 50 to 60 Hz. If you have any questions regarding the input voltage supply for your area, please ask your electric utility company.

To install the power cord, insert the female end of the power cord into the AC Adapter and then insert the female end of the cord from the AC Adapter into the A/C Power Cord Socket "C" located on the back panel of the tensioner. Plug the male end of the power cord into a grounded power outlet. When using extension cords, use grounded heavy duty extension cords rated for 15 AMP service.

To connect the foot pedal switch, insert the male pin at the end of the foot pedal switch cord into the Foot Pedal Switch Receptacle "B" located on the back panel of the tensioner.

Switch on the machine by pressing the Lighted On-Off Power Switch on the back panel. At start-up, the LED will display a countdown from "9.0" to "0.0" while the machine performs a self diagnostics check at start-up.

WARNING! FOR INDOOR USE ONLY.
NEVER OPEN UNIT WITH POWER CONNECTED.
CHILDREN SHOULD NEVER BE PERMITTED TO OPERATE THIS MACHINE WITHOUT ADULT SUPERVISION.

CONTROL PANEL FUNCTIONS AND FEATURES

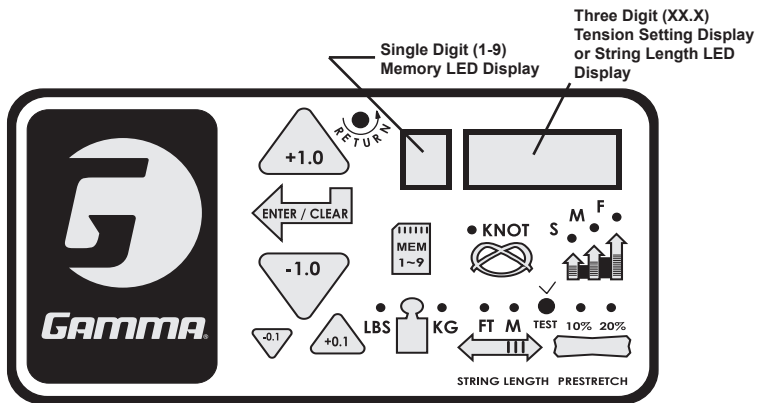

MAINTENANCE & ADJUSTMENTS

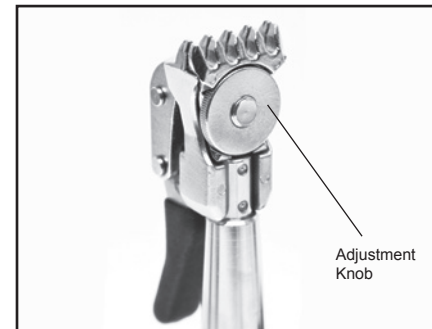

Adjusting the String Clamp Jaw Spacing

The string clamps will need minor adjustments according to what string type, construction, and gauge you are using.

To adjust the gap (clamping pressure) between the clamp jaws, insert the string through the racquet as if you were beginning the main strings. Clamp the strings and pull tension. If the string slips through the jaws of the clamp, tighten the clamp by squeezing the clamp jaws together by hand while turning the Adjustment Knob, in the clockwise direction. If the clamp leaves

impressions or damages the string, it may be excessively tight and should be adjusted by turning the Adjustment Knob counter clockwise to open the gap between the jaws. The clamp jaws should be cleaned periodically to be free from dirt, oil, and any string coating residue to grip properly. Knife sharpening stones are excellent for removing build-up on the diamond coated surfaces and are available.

Tension Index Buttons - Changes tension setting in +/- 1.0 or +/- 0.1 Lb or Kg increments. Holding the button down will scroll the tension setting values up or down. Tension settings entered with the tension index buttons are placed into temporary memory setting "0".

Memory Button - Indexes from 9 preset tension settings that can be stored in memory. Settings are retained even if machine is turned off. Each press of the button indexes to the next memory setting. Memory settings 1-9 must be entered using the keypad followed by pressing the "ENT" button.

Clear Button - Clears display to enter a new tension or to reset String Length Meter measurement.

Enter Button - Saves displayed tension for Memory setting - when tension is entered using the keypad display flashes until this button is pressed to save the setting. Also Clears display for String Length Meter measurements.

Test Button & Racquet Strung - Press once for approximate number of racquets strung. Press again to return. Press and hold for 5 seconds and the machine does an internal diagnostic check, such as the one performed at start-up.

Knot Function - Increases pulling tension by 10% over the setting value (max 90 lbs / 40.8 kgs) for one pull. During the pull the LED stays lit to indicate the Knot function is enabled.

Lbs/Kgs Button - Changes tension display from Lbs to Kgs. Each press of the button toggles back and forth between Lbs and Kgs.

Speed Button - Changes pulling speed of winder from Fast (default) to Medium to Slow. Slow speed is recommended for low stretch strings, such as Kevlar. Each press of the button toggles between Fast, Medium and Slow speeds.

Pre-Stretch Function - Pulls string 10% or 20% over the tension setting (up to 90 lbs / 40.8 kgs), releases the string, and repulls to the tension setting. Each press of the button toggles between 10%, 20% or no pre-stretch.

String Length Meter Button - feature is currently not available.

Clamp Base Locking Nut Adjustment

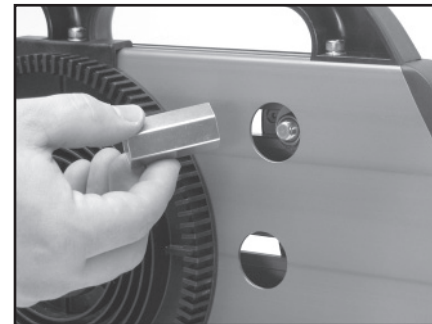

In the event the Locking Lever rotation is insufficient to ensure smooth operation of the clamp base, very minor adjustments to the Clamp Base Locking Nut can be made with the supplied 17mm socket. Tighten or loosen the locking nut in very small increments to provide more clamping pressure or running clearance as needed.

Quick Action Clamp Base Removal

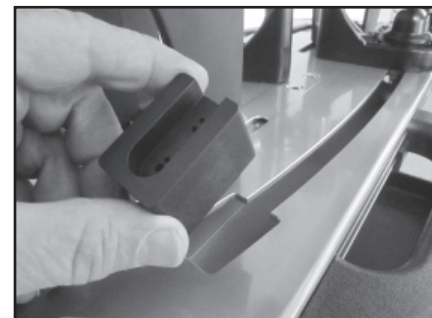

Quick Action clamp bases can be removed from the turntable for maintenance or cleaning by removing clamp stop located at the end of the slot in the turntable. To remove the clamp stop, remove the two screws holding the clamp stop in place from the underside of the turntable. Lift the clamp stop out of the slot, slide the clamp base to the end of the slot and lift it out. Replace the clamp base and clamp stop in reverse order.

CALIBRATION

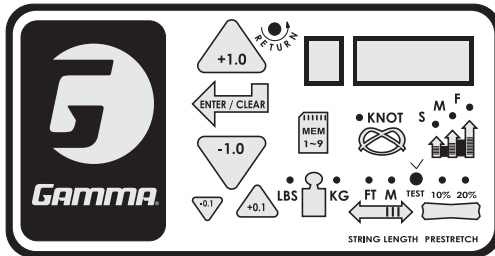

Tension Calibration Procedure

Each stringing machine has been checked and calibrated at the factory using accurate load sensing devices to ensure that the machine pulls at the correct tension. However, if you suspect that your machine may not be pulling at the correct tension you can check the pulling tension with a calibrator and make adjustments if needed.

Most tension calibrators (such as a Gamma Tension Calibrator) function by clamping off the string attached to one the end of the calibrator and applying tension to the string located on the opposite end of the calibrator. The tension measured by the calibrator will then display the tension being applied to the calibrator by the machine. If the calibrator and tensioner do not match then you can adjust the tensioner as follows:

- (1) Turn the machine off and restart the machine while holding down the Test button until the count down is complete. 22 lbs should appear on the display.
- (2) Apply tension to the calibrator.
- (3) If the tension reading on the calibrator does not match the tension displayed on the machine, use the tension indexing buttons to match the display to the calibrator reading and press the Enter/Clear button
- (4) Release the tension applied to the calibrator and 44 lbs should appear on the display.
- (5) Repeat steps #2-#4 for 44, 66 & 88lbs.
- (6) After completing the adjustment at 88lbs the display will show 00 lbs.
- (7) Restart the machine without holding any buttons and the calibration adjustment will be complete.

Switching the Buzzer Off and On

The stringing machine is equipped with a buzzer that sounds when any key or button is pressed or when there is a problem with some function of the machine. The buzzer can be disabled if desired for normal keypad entries.

To disable the buzzer, turn the machine on and while the display is counting down from 9 to 0, press and hold the Enter/Clear button for at least 5 seconds. The buzzer will be disabled and will remain disabled. It can be enabled again by following the same steps listed above.

Note: Even when disabled, the buzzer will sound if the tensioner has a problem and the machine requires attention. This is meant to alert the user of a problem, and can not be disabled.

MOUNTING THE FRAME



Adjusting the Frame Mounting Stands

Loosen the lock bolts of the frame support posts and space them apart with the frame support slides separated by the approximate length of the racquet head. Although it is not required, it is good practice to center the support posts on the turntable. Lock one of the posts in position by tightening the lock bolt and position the other post until the frame support slide is positioned near the inside surface of the racquet frame. Securely tighten the lock bolt of the second support post.

Caution: To avoid racquet damage, the center posts should not contact the racquet prior to locking down the support posts.

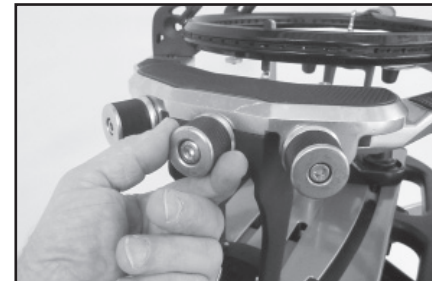

Tightening the Frame Supports

Tighten the Frame Support Slides by turning the adjustment knob clockwise until snug against the racquet frame and slight resistance is felt.

Caution: Overtightening the Center Supports will stretch the head of the racquet and could cause racquet damage.



Frame Shoulder Support Adjustment

Being sure the shoulder supports are free to swivel in their mountings, simultaneously rotate the shoulder support adjustment knobs clockwise until both shoulder supports gently and squarely contact the frame.

MOUNTING THE FRAME



Frame Shoulder Support Adjustment

The shoulder supports are designed to rotate and can be adjusted to provide maximum support to the racquet frame. Rotate the support so that the pads contact the frame squarely when the arms are closed against the racquet. Should the shoulder supports block string holes, adjust the frame support slides to re-position the racquet between the arms so the shoulder supports make contact with the racquet between grommet holes.



Securing the Frame Shoulder Clamps

Lock the shoulder supports in position by turning the knob at the base clockwise.

Repeat the adjustment procedure for the remaining support post.

Re-tighten all of the frame supports in the same order as before.

Do not overtighten any of the supports as racquet damage may occur.

The supports should be tightened to the point where the racquet frame will not move in the

mounting system when the handle is grasped and attempts are made to move it. Should any supports lose contact with the frame while stringing, they should be re-tightened.

PATHFINDER AWL

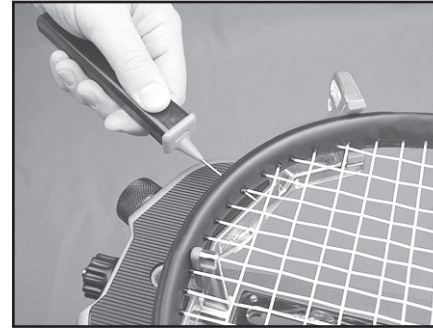

The machine includes the pathfinder stringing awl which creates a pathway between or around strings to make inserting a string through blocked grommets easier and quicker.

Insert the awl through the grommet hole in the same manner as for traditional awls. The Pathfinder awl must be in the closed position before insertion.

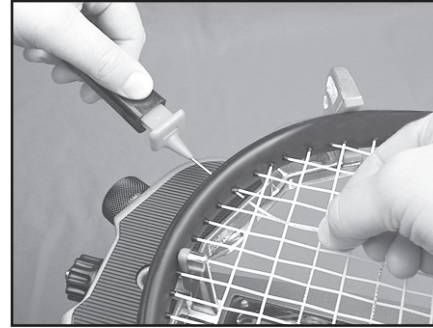

Once the awl is inserted, pull the handle of the awl outward while holding the tip section in place. This leaves the outer sheath in the grommet hole. Insert the end of the string into the outer sheath.

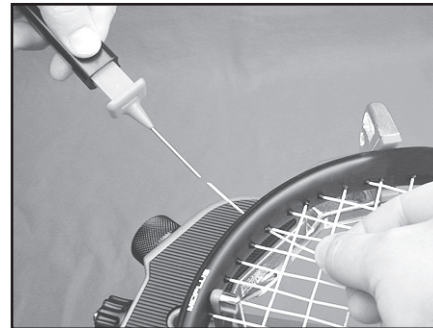

While holding the string, slowly pull the sheath out of the grommet hole to leave the free end of the string exposed.

ADDITIONAL FEATURES



Turntable Brake

The turntable may be locked in any position. Rotate the lever to the right to lock the turntable and to the left to release the turntable.

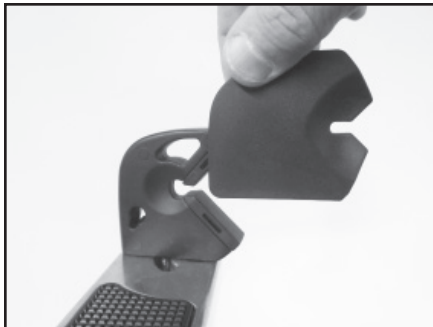

Badminton Shoulder Support Protection Pad Installation

Slide the badminton shoulder support cover over the shoulder supports. There is no need to remove the tennis shoulder supports.

Note: An optional badminton frame support for the head of the racquet is available.

STRINGING THE FRAME

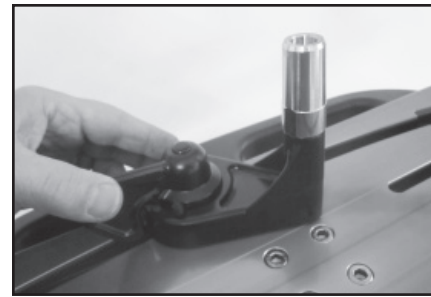

Clamp Base Operation

To lock the string clamp base to the turntable, rotate the clamp base locking lever clockwise. To release the string clamp base from the turntable, rotate the clamp base locking lever counter-clockwise.

The Locking Lever should be tightened enough to prevent clamp base slippage on the turntable, when the desired tension is placed on the string. To go from the loose position to the clamped position and back, generally requires the rotation permitted by the slot in the clamp base.



String Clamp Operation

The string clamps are a dual action design where the string clamp and clamp base operate independently of one another.

To clamp a string, lift the clamp head and place the string between the jaws and depress the string clamp lever to secure the string. The clamping pressure applied to the string should be adjusted to provide sufficient pressure to secure the string when subjected to the desired pulling tension. The diamond coated gripper plates provide for increased friction between the clamps and the string

to allow for reduced clamping pressure while securing and holding the string under tension.



Getting Started

To begin stringing the main strings, thread the two ends of the string through the two center holes at the appropriate end of the frame and continue through the opposite center holes. Thread one end of the string through the adjacent grommet hole and pull excess by hand.

Secure one of the strings using a string clamp.

STRINGING THE FRAME

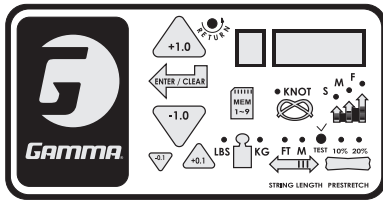

Setting the String Tension

String tensions may be entered and stored into one of nine memory storage settings (See section on Control panel Functions and features) by using the tension index buttons. While tension setting is entered, the value displayed will be temporary until the “Enter” button is pressed to store it in one of the nine permanent memory settings.

Aramid fiber and metallic strings will generally string up tighter on the machine compared to synthetic or natural gut strings. Therefore, when stringing with Aramid (Kevlar, Technora) hybrid strings or metallic strings, we recommend setting tension 4-5 lbs. lower than you would normally use for synthetic or natural gut strings.

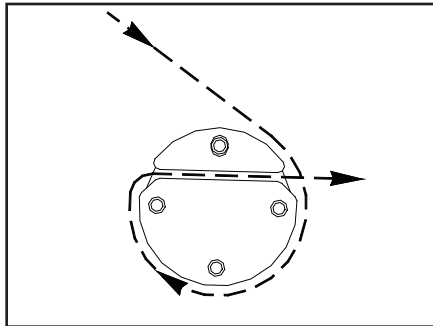

Applying Tension

To apply tension, wrap the string clockwise around the gripper drum and position the string between the gripper jaws.

The string must pass over the upper gripper jaw before being placed between the gripper jaws, as the tension on the string provides the clamping force to the gripper jaws.

Before applying tension, gently pull the string until all slack is removed.

CAUTION: NEVER TENSION A STRING WITH YOUR FINGERS BETWEEN THE STRING AND THE UPPER GRIPPER JAW AS SERIOUS INJURY COULD RESULT IF YOUR FINGER IS CAUGHT BETWEEN THE STRING AND THE UPPER JAW DURING TENSIONING. PUSH GRIPPER REVERSING SWITCH OR ANY BUTTON IN CASE OF EMERGENCY.



To tension a string, push the tension switch or the foot pedal. The string gripper will rotate and slowly apply tension to the string. When the set tension has been attained, the gripper will stop rotating and the display will flash. As the tensioned string stretches, the gripper may rotate intermittently, maintaining the set tension.

To release the string after clamping, push the tension switch or foot pedal. If the string gripper does not release the string, depress and hold the return button to release the string.

STRINGING THE FRAME

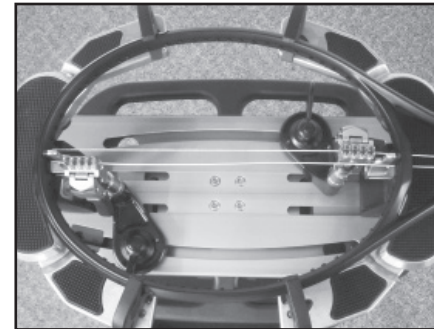

Clamping the First Main String

Secure the tensioned main string using the remaining fixed clamp. Repeat the procedure for all of the remaining racquet main strings and tie off following the racquet manufacturers recommendations.

Follow the manufacturer’s recommended stringing pattern for one or two piece stringing. This will determine the starting point for the cross strings. If applicable, tie the first cross string using an appropriate starting knot.

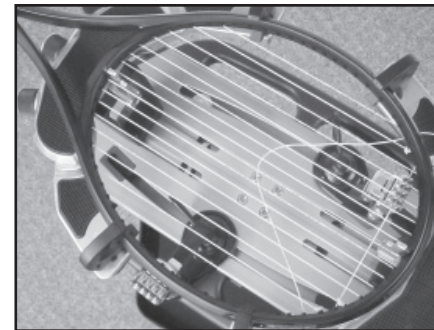

Weaving the Cross Strings

Weave the cross strings over and under the main strings being careful to alternate the weave direction of each consecutive cross string so as to be opposite of the previously installed cross string.

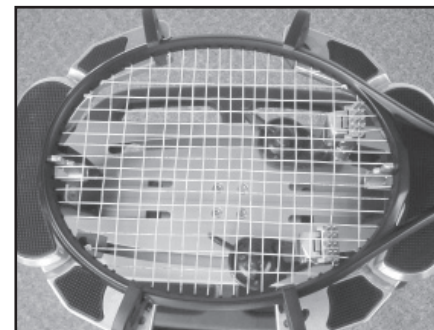

Completing the String Job

Once the final cross string is tensioned and clamped, tie off at the appropriate hole specified by the racquet manufacturer. Remove the frame from the mounting system by loosening the shoulder supports and frame supports.